

Application

Suitable for interior, top hung sliding panels.

Ideal for sliding panels and shutters in residential and commercial applications. Versatile design allows the opening to be covered by any number of panels.

The aluminium track may be fitted directly to the lintel, in single or multiple lines, or face fitted to the lintel using a single line of brackets. Pelmet accessory with end caps also available.

Hangers come standard with a steel bracket and four nylon tyred wheels with precision bearings. Clip stops provided but can be upgraded to a soft close device for improved operation.

Panel Specification

Track System:	Single Run 60
For Individual Panels:	
Max Panel Weight	60kg
Max Panel Height	2400mm
Min Panel Thickness	19mm

Standard Sets and Packs

Sets comprise of top track, brackets, hangers, clip stops or soft closes, guide, spanner and timber screws.

Set No.	Panel width	Track Length	Qty Brackets
SR60-20/1	610mm to 915mm	2000mm	5
SR60-30/1	915mm to 1525mm	3000mm	8
SR60-S20/1	610mm to 915mm	2000mm	5
SR60-S30/1	915mm to 1525mm	3000mm	8

Pack No.	
SR60-1PK	Fitting pack only, no track and brackets

Hardware Specification

Track:	60A
Material	Aluminium, Mill
Standard lengths	2000mm, 3000mm, 4000mm and 6000mm

Brackets:	
Single	91
Pack of 5 brackets	91/5

Bracket 91 made from stainless steel. Supplied with matching fasteners.

Hangers (2 per panel):	607
-------------------------------	-----

Hanger has a nylon body and comes standard with zinc plated steel bracket and four nylon tyred wheels with chrome precision bearings.

Clip Stops:	60CS
Adjustable clip stop made from POM, an engineered thermoplastic.	

Guide:	55G
Guide in white nylon, comes in two parts that fit on both sides of the panel. The guide is floor mounted.	

Spanner:	805-SPN to suit 607 Hanger.
-----------------	-----------------------------

Accessories:	
Soft Close	60SCT
Suitable for panels up to 60 kg.	

Pelmet and End Caps	63
Aluminium pelmet available in 2000mm and 3000mm lengths in powder coat white or clear anodised.	

Alternative Guide	801
-------------------	-----

Spring loaded guide, nylon body and tip with zinc plated steel shaft. Designed to slide in the 92 and 130 thresholds.

Alternative Guide	101N
-------------------	------

The nylon guide is designed to slide through a 20mm deep by 5mm wide sawcut in the bottom rail of the panel.

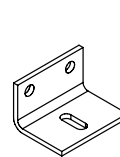
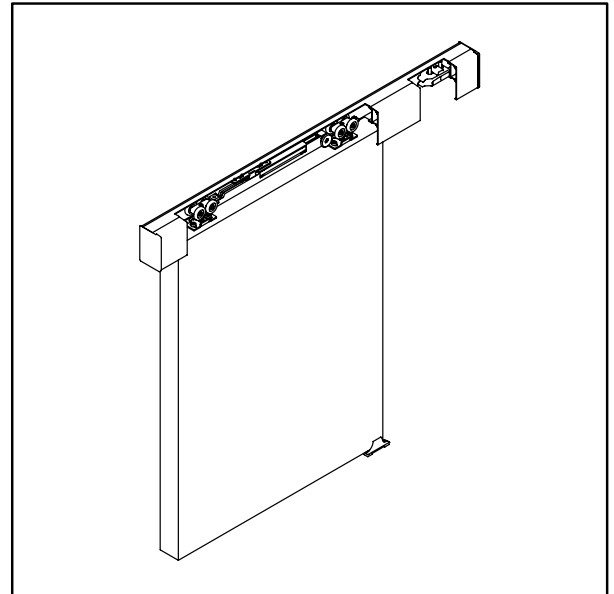

No. 91
BRACKET

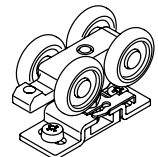

No. 607
HANGER

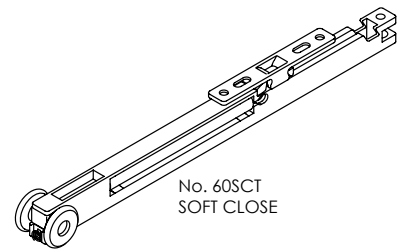

No. 60SCT
SOFT CLOSE

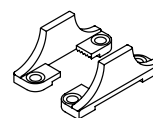

No. 55G
GUIDE
(SUPPLIED IN
SETS & PACKS)

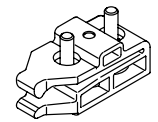

No. 60CS
CLIP STOP
(SUPPLIED IN
SETS & PACKS)



No. 801
GUIDE

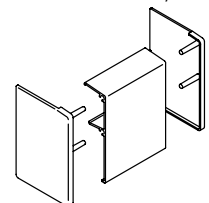

No. 63
PELMET

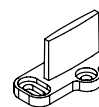

No. 101N
GUIDE

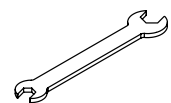

No. 805-SPN
SPANNER

91LS BRACKETS

Track Length	2000	3000	4000	6000
Bracket Qty.	5	8	10	15

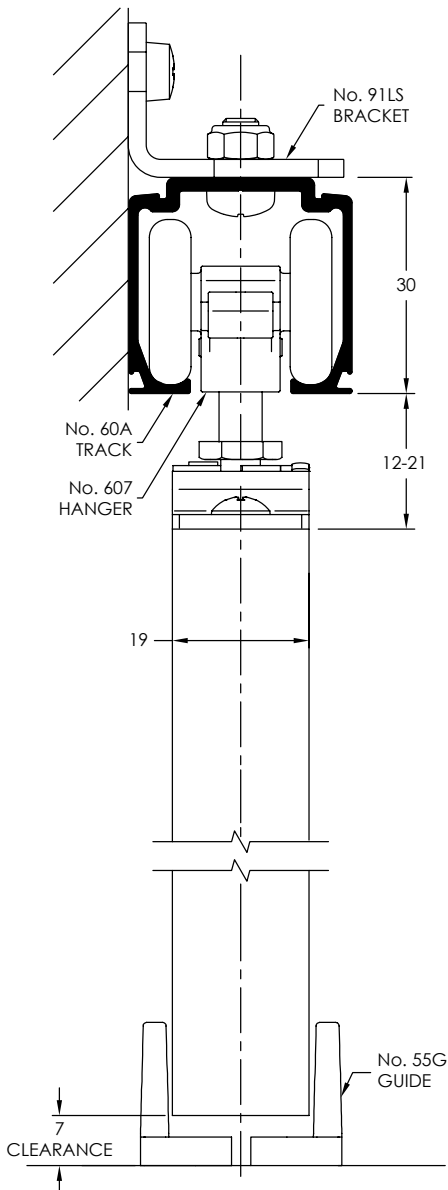

INSTALLATION INSTRUCTIONS

POSITION 1 (CLIP STOP)

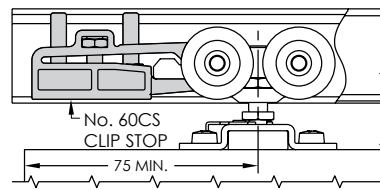

POSITION 2 (SOFT CLOSE)

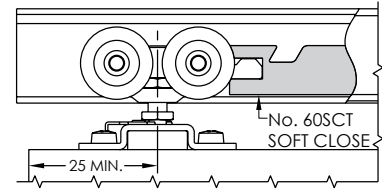

- 1** Fix Track Parallel to Floor

Soffit Fix: position 8g screws first 50mm in from each end and every 450mm approx centres.
Face Fix: use 91 brackets.
- 2** Attach Hardware to Panel

Hanger mounting plates should be positioned centrally to panel thickness.
- 3** Attach Hardware to Panel

Hanger mounting plates should be positioned centrally to panel thickness.
- 4** Fit Panel

Insert hardware into track.
With the latch on the mounting plates open, bring door up to hangers and push hanger bolt into plate. Close latches when bolts are in the plates.
- 5** Adjust Panel

Screw bolt in or out of hanger to adjust panel height. Adjust height so panel is square.
- 6** Fit Guide

Locate at opening jamb. With panel hanging plumb fix guides to either side of panel.
- 7** Fit Clip Stops or Soft Closes

Clip Stop - 1 each end. Outer screws fixing. Inner screw adjusts strength of clipping.
Soft close - install as per INST60SCT.

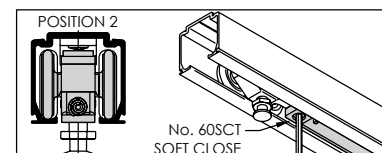
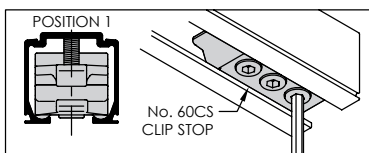
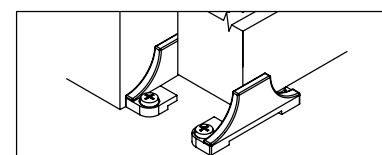
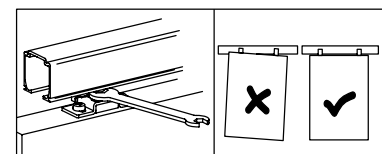
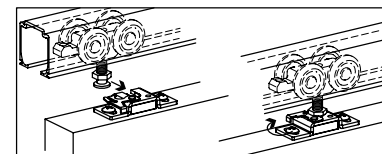
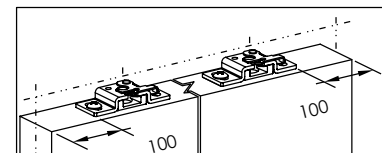
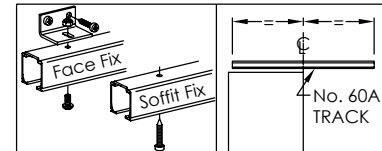

ALTERNATIVE GUIDES

