

RYOBI®

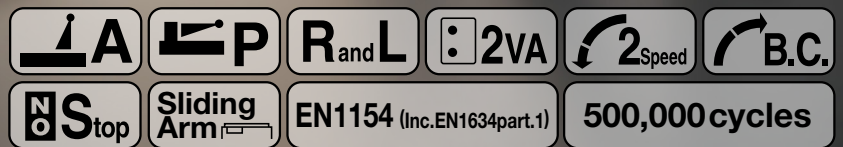

Overhead door closer **RYOBI**
D-1200 SERIES

Overhead door closer D-1200 SERIES

Model chart

Size	Without hold-open		Maximum door weight	Maximum door width	
	Without backcheck	With backcheck			
Size2	Standard application	D-1200	D-1200BC	40kg	850mm
Size3				60kg	950mm
Size4 (Position variable)				80kg	1100mm
Size2	Track-rail arm application	D-1200T	D-1200BCT	40kg	850mm
Size2	Parallel arm application	D-1200P	D-1200BCP	40kg	850mm

* : D-1200 univ is a set to handle both standard application and parallel arm application.

Compact body and smooth operation

CE EN1154 (inc. CE EN1634 part.1)

Optional backcheck function

Support of door sizes 2,3,4 with changes to mounting position

Non-handed

Wide color variation

D-1200
Standard application

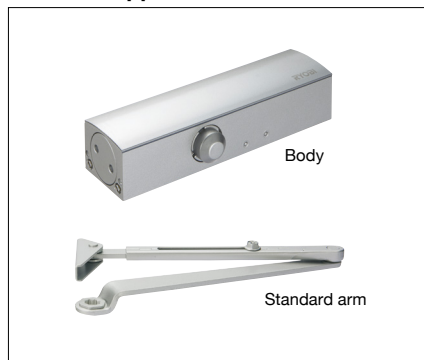

D-1200T
Track-rail arm application

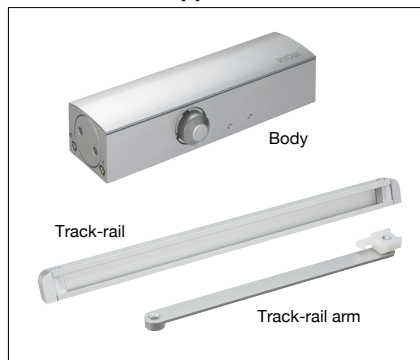

D-1200P
Parallel arm application

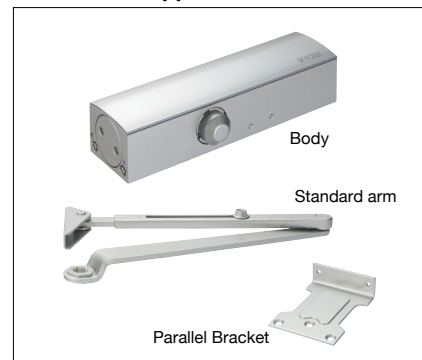

Color variation



Specification and adjustment

Two speed control valves

- There are two speed ranges for door closing speed.
- Those ranges are classified into two stages of the 1st speed range which controls overall door closing speed and the 2nd speed range which controls latching speed.
- Those speeds can be adjusted by respectively independent speed adjustment valves.

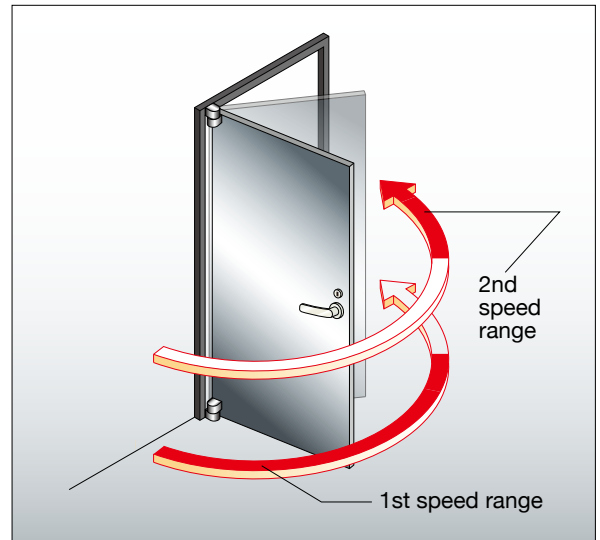

Backcheck function

- This function controls sudden door opening by strong wind, etc.
- This function prevents accidents, injuries, and door damage which occur due to a door suddenly opening by a strong wind or rough handling.
- This function works in a range of door opening angles from approx. 80 to 180 degrees.
- The door becomes heavier when it operates, however, this is all by design. The door opens if it is slowly opened.
- When installing the door closer equipped with the backcheck function, sufficiently reinforce hinges and pivots.

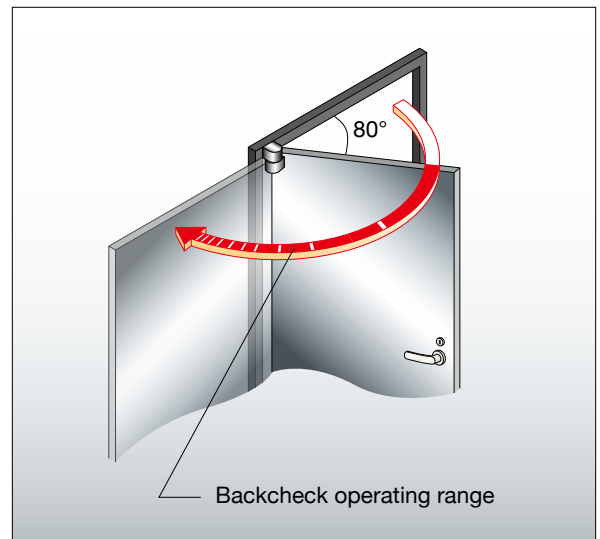

Position variable

- Door sizes 2,3,4 are supported with changes to the mounting position.

	Maximum door weight	Maximum door width
Size2	40kg	850mm
Size3	60kg	950mm
Size4	80kg	1100mm

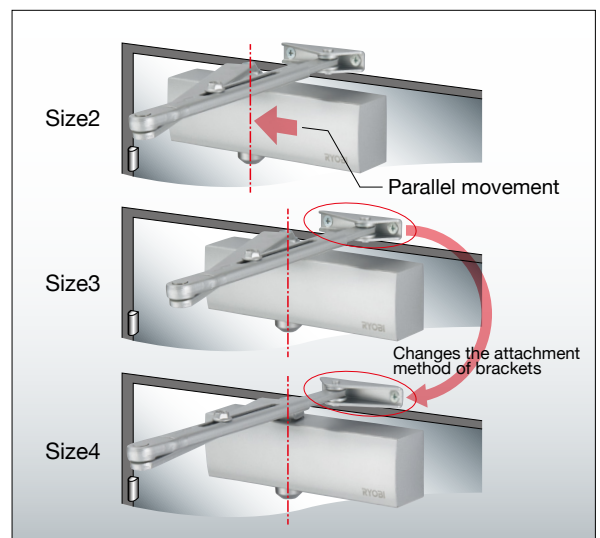



Size 2

Maximum door weight	Maximum door width
40kg	850mm

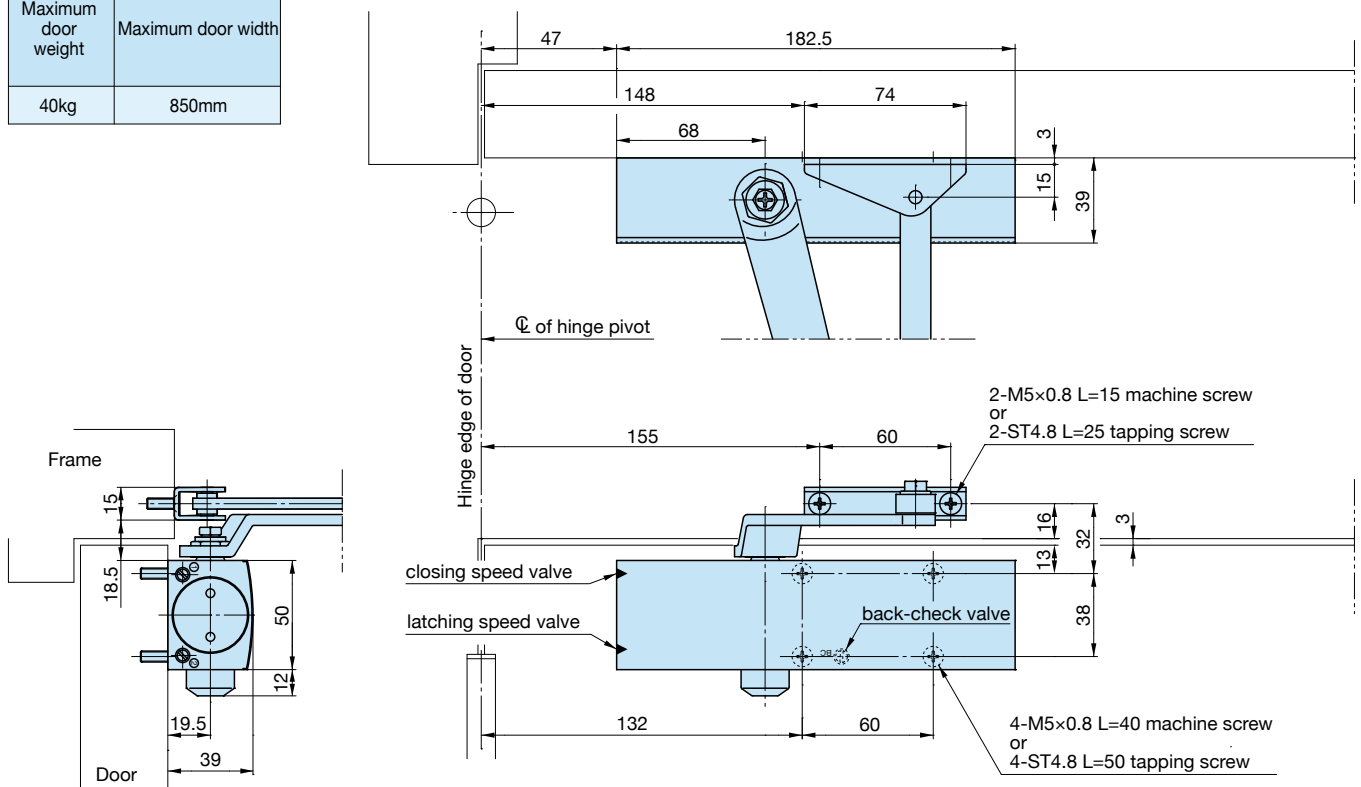

D-1200 Standard application

D-1200 / D-1200BC

Size 3

Maximum door weight	Maximum door width
60kg	950mm

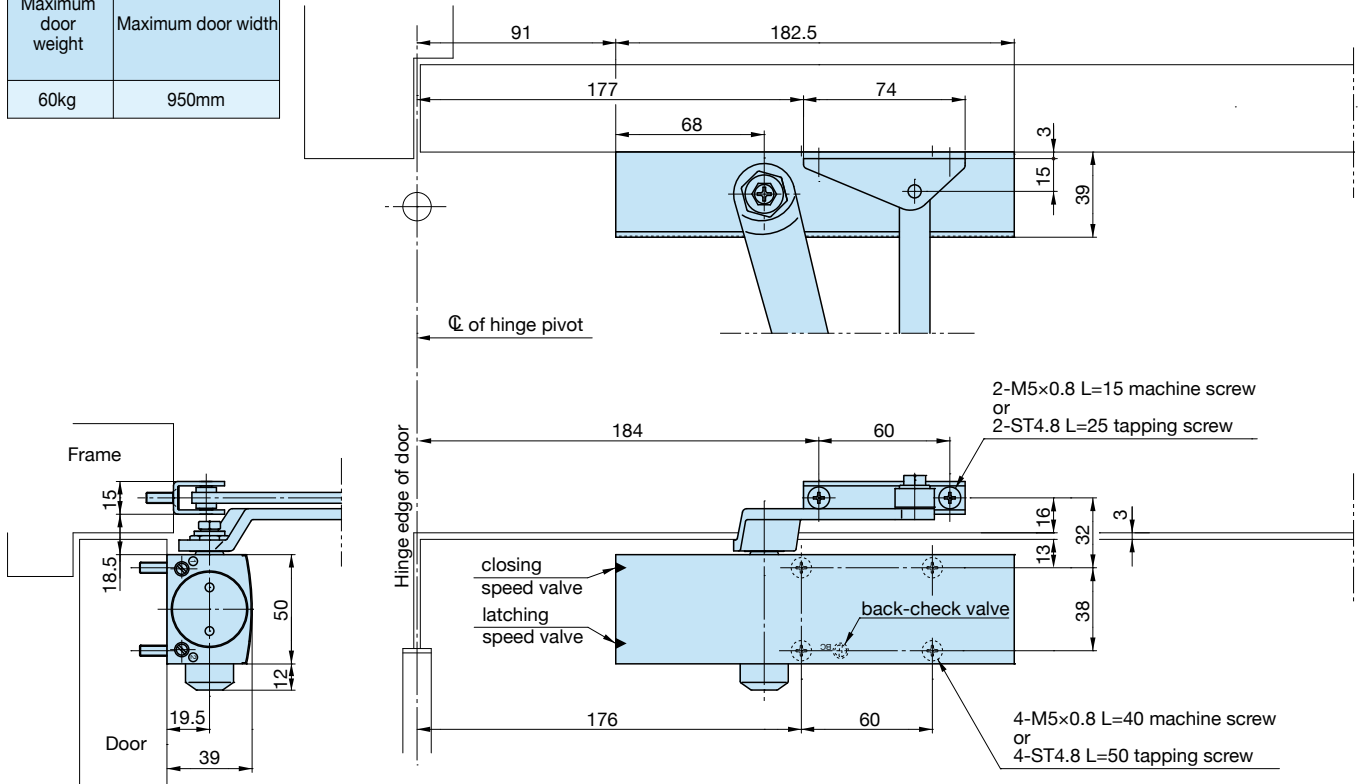

Size 4

Maximum door weight	Maximum door width
80kg	1100mm

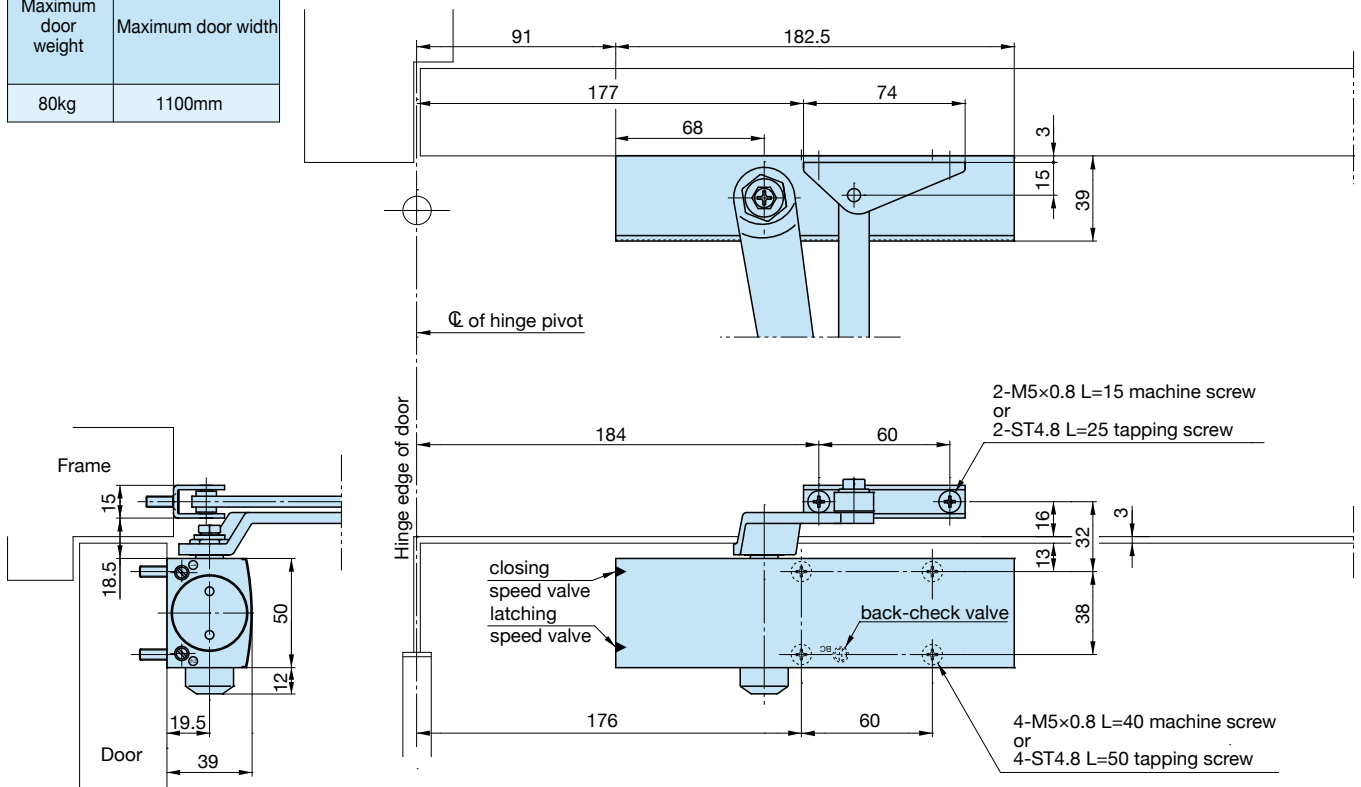



Maximum door weight	Maximum door width
40kg	850mm

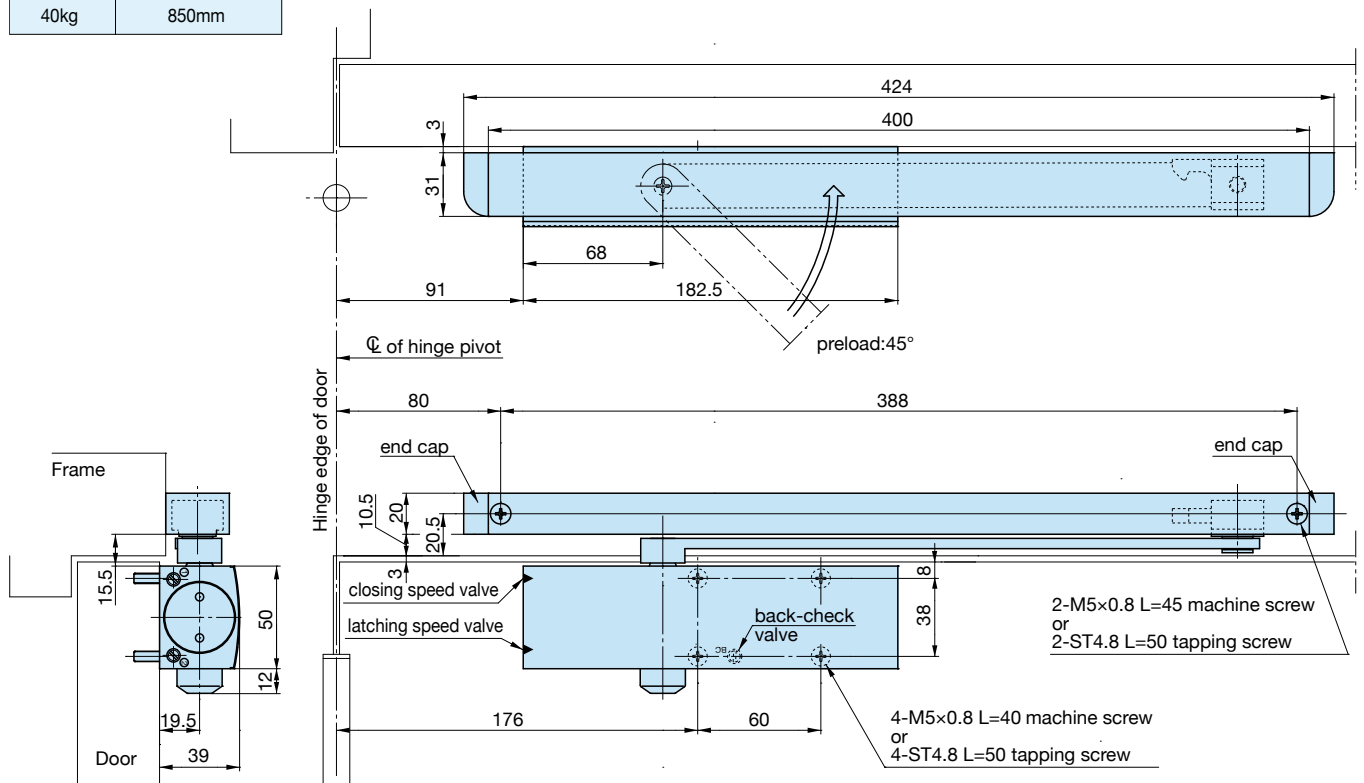

D-1200P Parallel arm application

D-1200P / D-1200BCP



Maximum door weight	Maximum door width
40kg	850mm

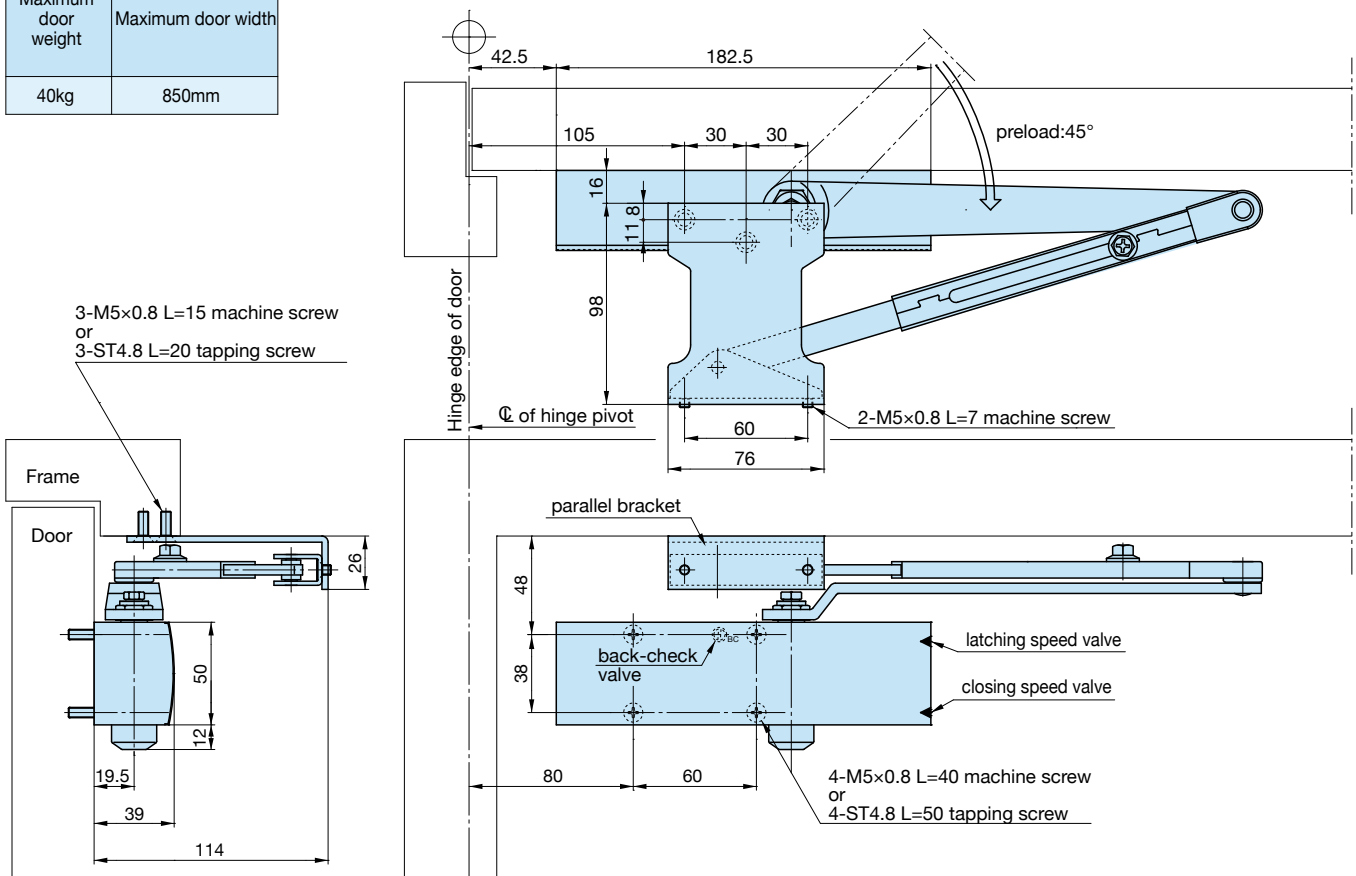

RYOBI LIMITED

5-2-8 Toshima, Kita-ku Tokyo 114-8518, Japan
Tel. 81-3-3927-5536 Fax. 81-3-3927-5527

RYOBI is a registered trade mark of Ryobi Limited